



## Data sheet

### Hydraulic data

Maximum operating pressure $p$	1.4 bar
Discharge port	G 1½
Free ball passage of the hydraulics	40 mm
Impeller type	Vortex impeller
Max. immersion depth	2 m
Max. delivery head $H_{\max}$	13.0 m
Max. volume flow $Q_{\max}$	22.1 m³/h
Min. fluid temperature $T_{\min}$	3 °C
Max. fluid temperature $T_{\max}$	40 °C
Min. ambient temperature $T_{\min}$	3 °C
Max. ambient temperature $T_{\max}$	40 °C

### Motor data

Mains connection	1~230 V, 50 Hz
Voltage tolerance	±10 %
Rated power $P_2$	0.75 kW
Power consumption $P_{1 \max}$	1.03 kW
Rated current $I_N$	4.7 A
Starting current $I$	14.2 A
Operating mode (immersed)	S1
Operating mode (non-immersed)	S3-20%
Rated speed $n$	2900 1/min
Power factor $\cos \varphi$	0.94
Activation type	Direct On Line (DOL)
Number of poles	2
Max. switching frequency $t$	30 1/h
Insulation class	F
Protection class motor	IP68

### Cable

Connection cable length	5 m
Cable type	H07RN-F
Cable cross-section	3G1 mm²
Type of connection cable	Detachable

**Equipment/function**

Mains plug	CEE7/7 (Schuko)
Float switch	yes
Macerator	no
Explosion protection type	-
Motor protection	Bimetall
Motor, leakage detection	no
Sealing chamber, leakage detection	no
Leakage chamber, leakage detection	no

**Materials**

Pump housing	Grey cast iron
Impeller	PK-GF30
Shaft	Stainless steel
Sealing on pump side	Carbon, synthetic resin-impregnated
Gasket material	NBR
Motor housing	Stainless steel

**Installation dimensions**

Inlet connection	-
Outlet connection	G 1½

Pump curves



Fluid media	Water 100 %
Fluid temperature <i>T</i>	20.00 °C
speed at duty point <i>n hydr. @ OP</i>	2900 1/min

Dimensions and dimensions drawings

Wilo-Rexa MINI3

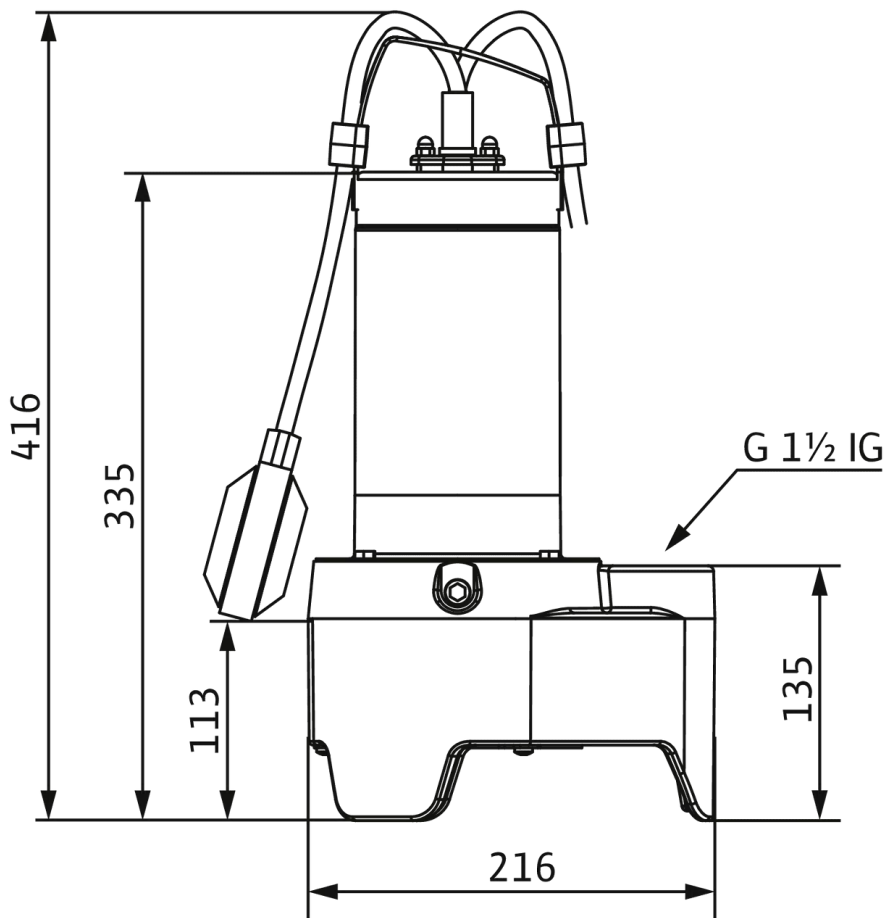

## Ordering information

### Product data

Brand	Wilo
Product description	Rexa MINI3-V04.13/M08-523/A-5M
Article number	<b>3094007</b> 
EAN number	4048482948744
Colour	silver/black
Minimum order quantity	1
Date of sales availability	2019-09-02

### Dimension, weight

Length with packaging	250 mm
Length <i>L</i>	216 mm
Height with packaging	530 mm
Height <i>H</i>	416 mm
Width with packaging	210 mm
Width <i>W</i>	164 mm
Gross weight, approx. <i>m</i>	15 kg
Net weight, approx. <i>m</i>	14 kg

### Packaging

Number per layer	15
Packaging property	Sales packaging
Packaging type	Euro pallet
Pieces per pallet	30